

Akuvox Smart Intercom

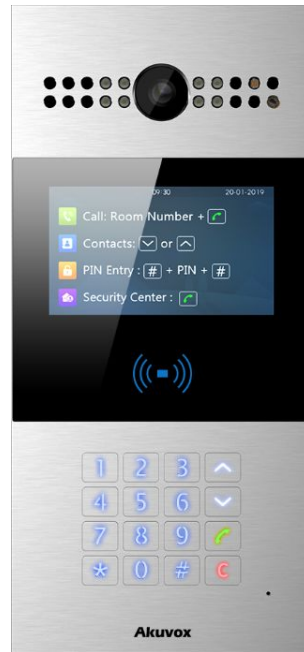

R28A

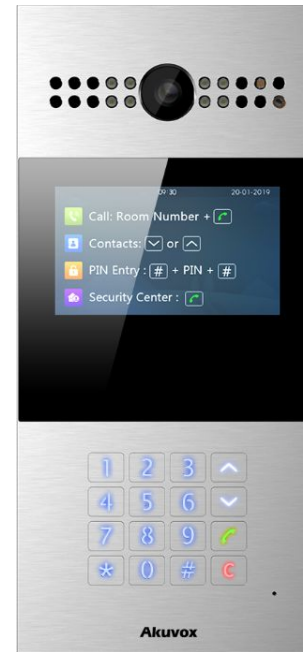

R28V

R28 Series Door Phone User Manual

About This Manual

Thank you for choosing Akuvox's R28AV door phone. This manual is intended for end users who need to properly configure the door phone. This manual is applicable to 28.0.3.xx version, and it provides an overview of the most essential functions and features of the product. Please visit Akuvox forum or consult technical support for any new information or latest firmware.

Note: Please refer to universal abbreviation form in the end of manual when meet any abbreviation letter.

Content

1. Product Overview	1
1.1. Product Description.....	1
1.2. Connector Introduction.....	1
2. Daily Use	3
2.1. Make a Call.....	3
2.2. Receive a Call.....	3
2.3. Unlock.....	4
2.3.1. Unlock by Public Pin Codes.....	4
2.3.2. Unlock by Private Pin Codes.....	4
2.3.3. Unlock by RFID Cards (Optional).....	5
2.3.4. Unlock by DTMF Codes.....	5

1. Product Overview

1.1. Product Description

Akuvox R28 is a SIP-compliant, hands-free and video door phone. It can be connected with Akuvox indoor monitors for remote access controlling and monitoring. Users can communicate with visitors via audio and video calls, and unlock the door if they need. Users can also use RFID cards to unlock the door (R28A only). It is applicable in apartments, offices and so on.

1.2. Connector Introduction

Ethernet (POE): Ethernet (POE) connector which it can provide both power and network connection.

12V/GND: External power supply terminal if POE connector is not available.

RS485A/B: RS485 terminal.

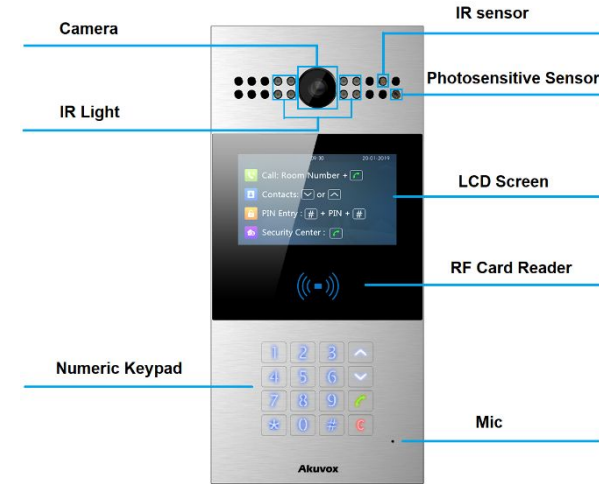

Figure 1.1 Product description

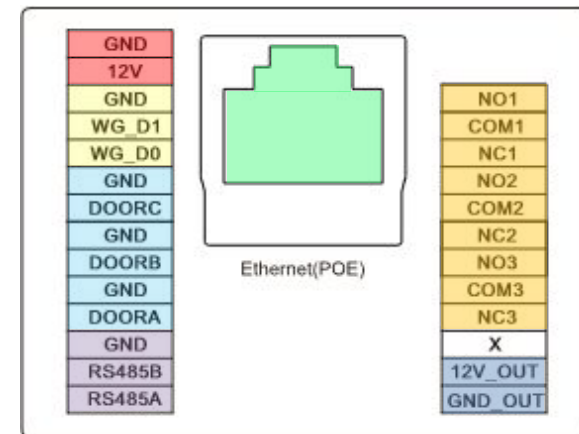

Figure 1.2-1 R28's interface

WG_D0/WG_D1: Wiegand terminal.

DOORA/B/C: Trigger signal input terminal.

RelayA/B/C (NO/NC/COM): Relay control terminal.

12V_OUT/GND_OUT: Power output terminal.

Note: The general door phone interface diagram is only for reference.

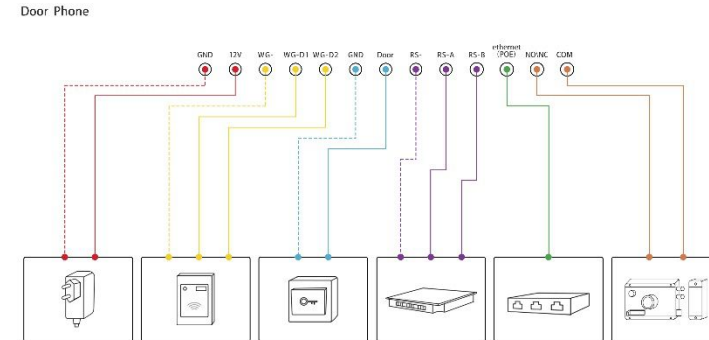

Figure 1.2-2 General interface

2. Daily Use

2.1. Make a Call

Call: Users can make a call by entering room number, SIP extension or IP address and then press “Dial key.”

Security center call : Users can make a speed dial to security center by pressing “Dial Key” directly.

Call from contacts: Users can press “Up/Down key” to enter contacts interface, select the contact to dial to by pressing up/down key on contacts interface and press “Dial key” to make a call.

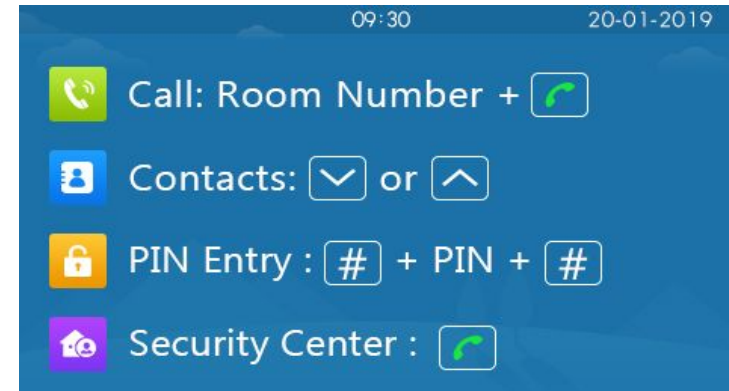

Figure 2.1-1 Idle interface

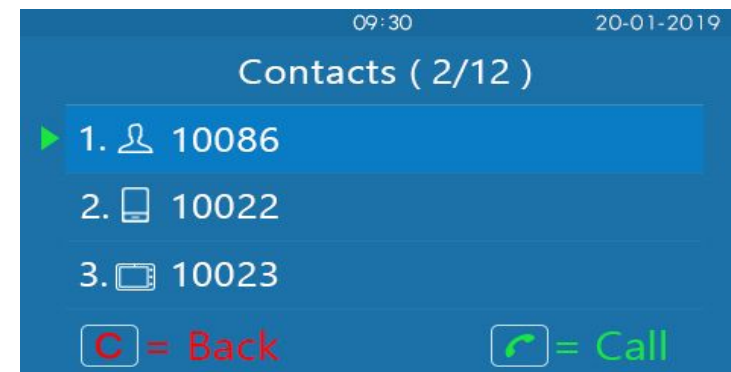

Figure 2.1-2 Contacts interface

2.2. Receive a Call

R28 will auto answer the incoming call by default. If users disable auto answer function, they can press “Dial key” to answer the incoming call.

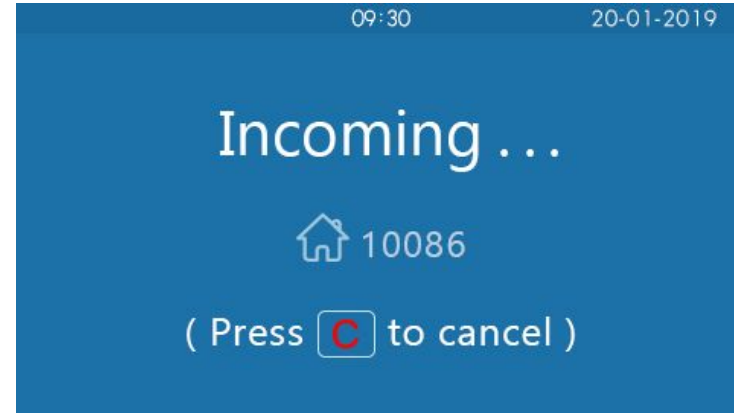

Figure 2.2 Incoming call interface

2.3. Unlock

Unlock by Public Pin Codes

Users can unlock doors by using predefined public pin code. Press “#,” public pin code, “#” to unlock, and then users will hear “The door is now opened.” If users press wrong public pin code, the screen will show “Incorrect PIN.” The default public pin code is 33333333. The default public pin code is 8 digits, and it can be changed to 3 to 8 digits.

Unlock by Private Pin Codes

Users can unlock doors by using predefined private pin code. Press “#,” private pin code, “#” to unlock, and then users will hear “The door is now opened.” If users press wrong private pin code, the screen will show “Incorrect PIN.” The default private pin code is 8 digits, and it can be changed to 3 to 8 digits.

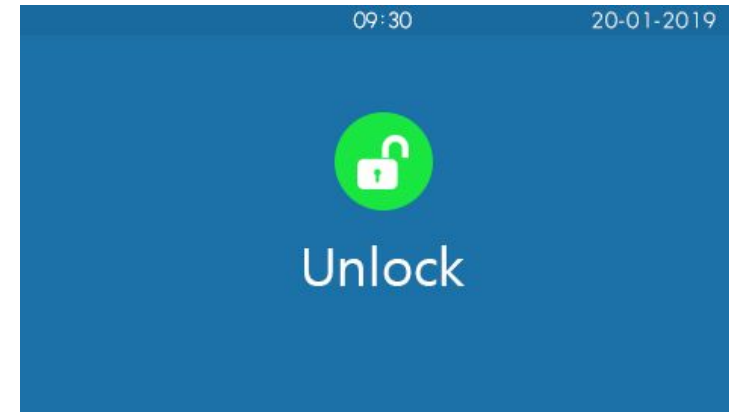

Figure 2.3.1-1 Unlock interface



Figure 2.3.1-2 Unlock failed interface

Unlock by RFID Cards (Optional)

Place the predefined user cards in RFID card reader to unlock. Under normal conditions, R28A will announce “The door is now opened.” If the card has not been registered, R28A will show “Unauthorized.” Both 13.56MHz and 125KHz RFID cards are supported on R28A.

Unlock by DTMF Codes

Users can press the predefined DTMF code from an answer unit to remotely unlock the door during the call. Users will also hear “The door is now opened.”

Abbreviations

ACS: Auto Configuration Server

Auto: Automatically

AEC: Configurable Acoustic and Line Echo Cancelers

ACD: Automatic Call Distribution

Autop: Automatic Provisioning

AES: Advanced Encryption Standard

BLF: Busy Lamp Field

COM: Common

CPE: Customer Premise Equipment

CWMP: CPE WAN Management Protocol

DTMF: Dual Tone Multi-Frequency

DHCP: Dynamic Host Configuration Protocol

DNS: Domain Name System

DND: Do Not Disturb

DNS-SRV: Service record in the Domain Name System

FTP: File Transfer Protocol

GND: Ground

HTTP: Hypertext Transfer Protocol

HTTPS: Hypertext Transfer Protocol Secure

IP: Internet Protocol

ID: Identification

IR: Infrared

LCD: Liquid Crystal Display

LED: Light Emitting Diode

MAX: Maximum

POE: Power Over Ethernet

PCMA: Pulse Code Modulation A-Law

PCMU: Pulse Code Modulation μ -Law

PCAP: Packet Capture

PNP: Plug and Play

RFID: Radio Frequency Identification

RTP: Real-time Transport Protocol

RTSP: Real Time Streaming Protocol

MPEG: Moving Picture Experts Group

MWI: Message Waiting Indicator

NO: Normal Opened

NC: Normal Connected

NTP: Network Time Protocol

NAT: Network Address Translation

NVR: Network Video Recorder

ONVIF: Open Network Video Interface Forum

SIP: Session Initiation Protocol

SNMP: Simple Network Management Protocol

STUN: Session Traversal Utilities for NAT

SMTP: Simple Mail Transfer Protocol

SDMC: SIP Devices Management Center

TR069: Technical Report069

TCP: Transmission Control Protocol

TLS: Transport Layer Security

TFTP: Trivial File Transfer Protocol

UDP: User Datagram Protocol

URL: Uniform Resource Locator

VLAN: Virtual Local Area Network

WG: Wiegand

Contact us

For more information about the product, please visit us at www.akuvox.com or feel free to contact us by

Sales email: sales@akuvox.com

Technical support email: techsupport@akuvox.com

Telephone: +86-592-2133061 ext.7694/8162

We highly appreciate your feedback about our products.

